

**MINIATURE GENERAL PURPOSE PLASTIC RECTIFIER**

**FEATURES**

- The plastic package carries Underwrites Laboratory Flammability Classification 94V-0
- Construction utilizes void-free molded plastic technique
- Low reverse leakage
- High forward surge current capability
- High temperature soldering guaranteed:260°C/10 seconds at terminals
- Component in accordance to RoHs 2002/95/EC and WEEE 2002/96/EC

**MECHANICAL DATA**

- *Case:* R-1 molded plastic body
- *Terminals:* Lead solderable per MIL-STD-750,method 2026
- *Polarity:* Color band denotes cathode end
- *Mounting Position:* Any
- *Weight:* 0.007ounce, 0.19 gram

**R-1**

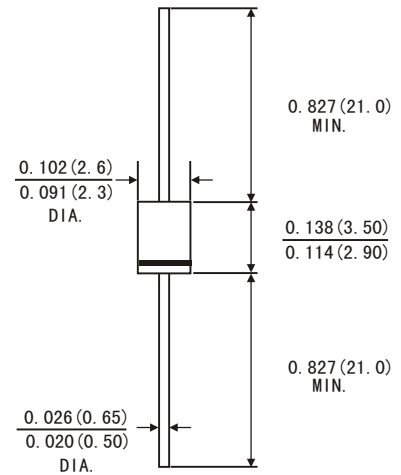

Dimensions in inches and (millimeters)

**MAXIMUM RATINGS AND ELECTRICAL CHARACTERISTICS**

(Ratings at 25°C ambient temperature unless otherwise specified ,Single phase ,half wave 60Hz,,resistive or inductive load. For capacitive load, derate by 20%.)

	Symbols	1A1	1A2	1A3	1A4	1A5	1A6	1A7	Units
Maximum recurrent peak reverse voltage	VRRM	50	100	200	400	600	800	1000	Volts
Maximum RMS voltage	VRMS	35	70	140	280	420	560	700	Volts
Maximum DC blocking voltage	VDC	50	100	200	400	600	800	1000	Volts
Maximum average forward rectified current 0.375"(9.5mm) lead length TA=25°C	I(AV)	1.0							Amp
Peak forward surge current (8.3ms half sine-wave superimposed on rated load (JEDEC method)at TA=75°C	IFSM	25.0							Amps
Maximum instantaneous forward voltage at 1.0 A	VF	1.1							Volts
Maximum reverse current at rated DC blocking voltage	IR	5.0							μA
		500							
Typical thermal resistance (Note 2)	RθJA	60.0							°C/W
Typical junction capacitance (Note 1)	CJ	15.0							PF
Operating and Storage temperature Range	TJ TSTG	-65 to+150							°C

**Note:** 1.Measured at 1MHz and applied reverse voltage of 4.0V dc.

2.Thermal resistance from junction to ambient and from junction to lead at 0.375"(9.5mm)lead length ,p.c.b. mounted

# RATINGS AND CHARACTERISTIC CURVES 1A1 THRU 1A7

FIG.1-FORWARD CURRENT DERATING CURVE

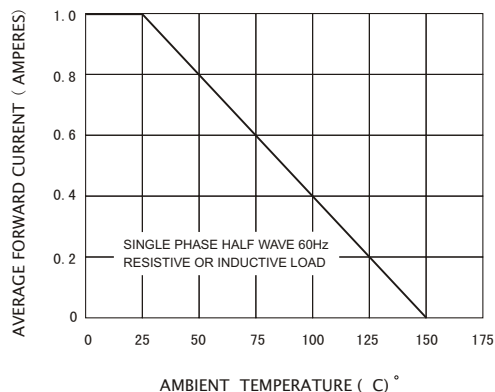

FIG.2-TYPICAL INSTANTANEOUS FORWARD CHARACTERISTICS

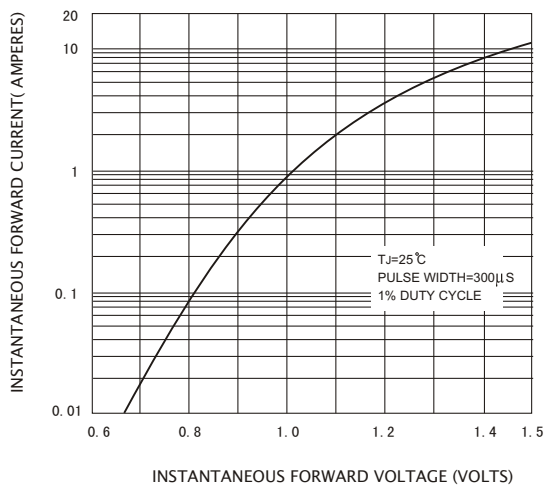

FIG.3-MAXIMUM NON-REPETITIVE PEAK FORWARD SURGE CURRENT

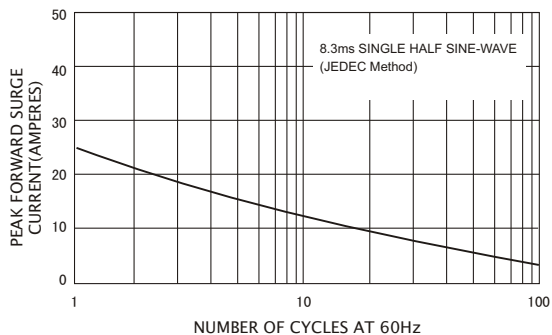

FIG.4-TYPICAL REVERSE CHARACTERISTICS

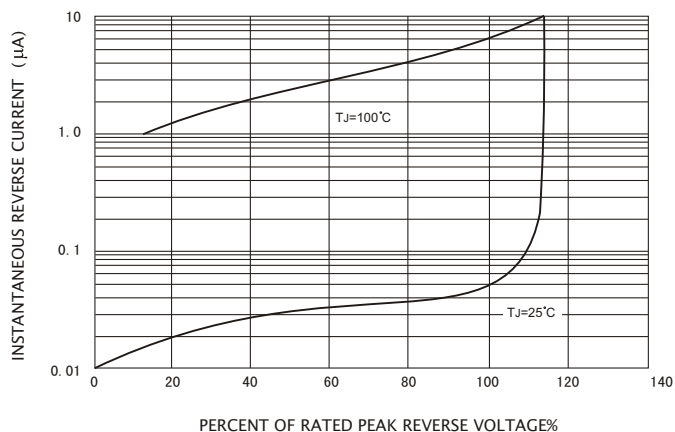
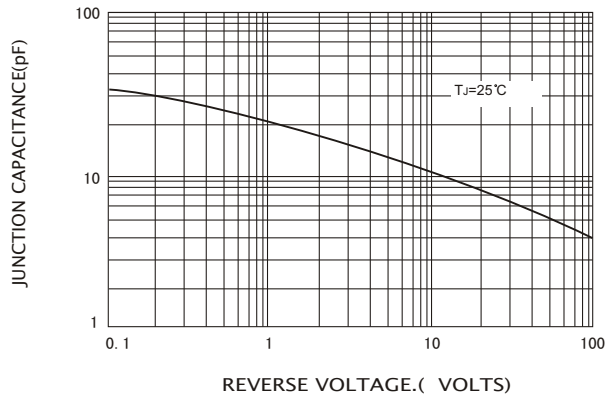
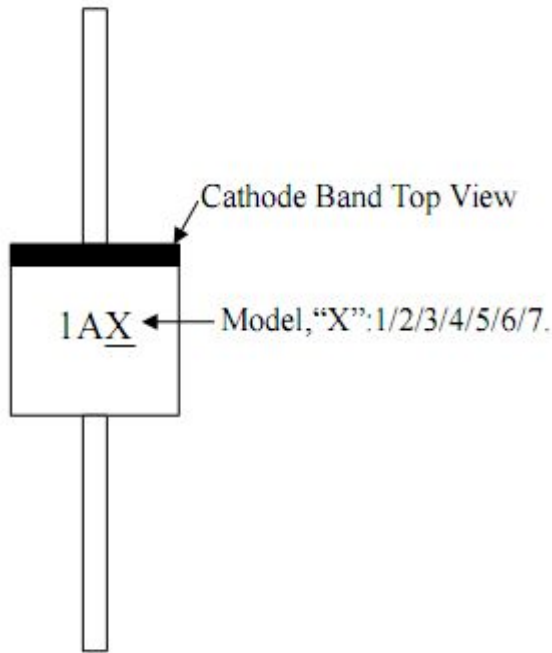

FIG.5-TYPICAL JUNCTION CAPACITANCE





**NOTES:**

■ HONGXIN reserves the right to make changes to this document and its products and specifications at any time without notice.

■ Customers should obtain and confirm the latest product information and specifications before final design, purchase or use.

■ HONGXIN makes no warranty, representation or guarantee regarding the suitability of its products for any particular purpose, nor does HONGXIN assume any liability for application assistance or customer product design.

■ HONGXIN does not warrant or accept any liability with products which are purchased or used for any unintended or unauthorized application.

■ No license is granted by implication or otherwise under any intellectual property rights of HONGXIN.

■ HONGXIN products are not authorized for use as critical components in life support devices or systems without express written approval by HONGXIN.

**CONTACT INFORMATION:**

DONGGUAN HONGXIN ELECTRONIC CO.,LTD

TEL:0769-83722095/83722096/38832588

FAX:0769-83722090/38832587

E-Mail:hongxin@hongxin-dg.com.cn

<http://www.hongxin-dg.com.cn>

Address: No.1, gongye roab, shangchegang, gekeng village, hengli town, dongguan city, china.